

## TOOLS REQUIRED FOR MX-2 INSTALLATION

- |                              |  |  |
|------------------------------|--|--|
| 1. Screwdriver, Phillips tip | 4. One tube approved bathroom sealant      | 7. 1/4" drill bit for plastic anchors                    |
| 2. Caulking Gun              | 5. Mill file to smooth cut edges or radius | 8. 1/4" carbide bit for ceramic tile anchor installation |
| 3. Hacksaw                   | 6. 1/8" drill bit for 6 x 3/8" screws      |  |



10 x 2 FLAT



10 X 2 PAN

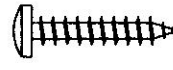

6 x 3/4 PAN



6 x 3/8 PAN



Anchor

## INSTALLATION INSTRUCTIONS FOR MODEL MX-1

1. Measure finished opening in center of sill at the bottom of shower stall. Cut #6 threshold to that measurement. Place threshold on center of sill. You may have to radius ends of threshold to fit fiberglass stalls.

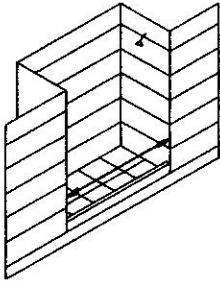

2. Locate and mark hole location on both #3 wall jambs. Be sure jambs are plumb and on threshold.

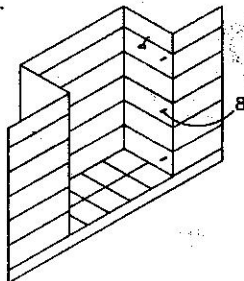

3. Drill 1/4" holes and install plastic anchors. Secure wall jambs with #9 10x2 Pan Head Screws.

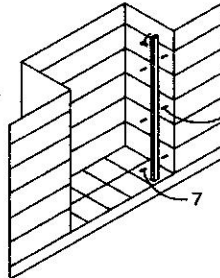

4. Place hinge portion of door into jamb in extended position. Drill and temporarily fasten with sheet metal screw at top.

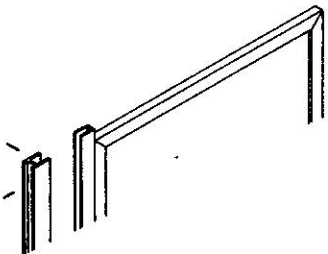

5. Insert #2 strike jamb into wall jamb. Adjust door and magnetic strike to operate properly.

**NOTE:** If your door does not close properly, reverse magnet end for end in strike jamb.

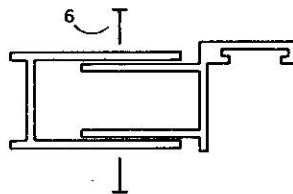

6. Make final adjustments and secure with #8 6x3/8 screws. Three screws should be used inside and outside of each wall jamb.

Use one 6X3/4" Pan screw on each end of threshold

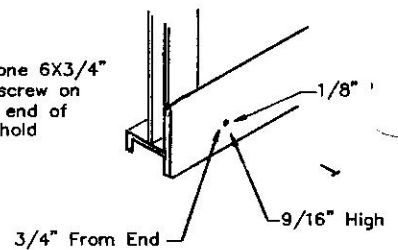

7. Install #4 gutter and #5 gutter vinyl with three #8 6x3/8 screws. Be sure gutter slopes to the hinge side of door. Adjust vinyl to cover open space under door to 1/8" of sill. Put gutter plug at leading end of gutter. Round corner with a file at this time.

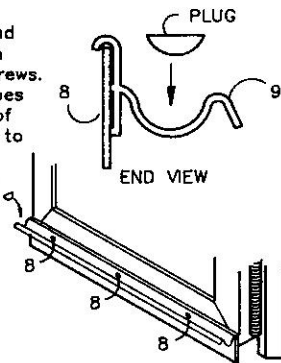

8. Measure width of opening between the top of strike jamb and the hinge jamb, and cut the strike jamb. Notch according to this illustration and install with 2 10x2 flat head screws.

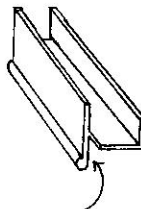

Notch this back 7/16" on strike jamb side.

9. Clean unit and run a continuous bead of sealant outside wall jambs to walls, and threshold to sill. Do NOT seal inside of unit.

**NOTE:** We recommend filing any sharp corners that could cause injuries.

## FABRICATION INSTRUCTIONS

1. Establish opening measurement.
2. Top and bottom door rails = opening measurement minus 3 1/4 inches.  
Example: 29 5/8" opening minus 3 1/4" = 26 3/8" rail and 24 3/8" glass.

**NOTE:** Expansion will allow for plus or minus 1/2 inch on door.

Width  
Door Width - 2"

Glass Size

Standard Height  
66 3/4"

### Note on K.D. units

Top and bottom door rails will be shipped in one piece, mitered and punched at both ends, so it can be cut in two to give required length for custom fabrication.

Unless otherwise specified, 7/32 glazing channel will be provided. 1/4 inch also available.

★ **PLEASE NOTE:** Before beginning the installation, check that parts contained in the carton and hardware package match those parts listed below. If you should find any discrepancies please contact Holcam Sales at 1-800-843-3332.

**WARNING**

TO AVOID DAMAGING THE FINISH OF THIS DELUXE SHOWER ENCLOSURE, USE ONLY MILD CLEANERS. ALWAYS READ THE LABELS ON THE CLEANER USED. DO NOT USE HARSH CHEMICALS OR ABRASIVE DETERGENTS.

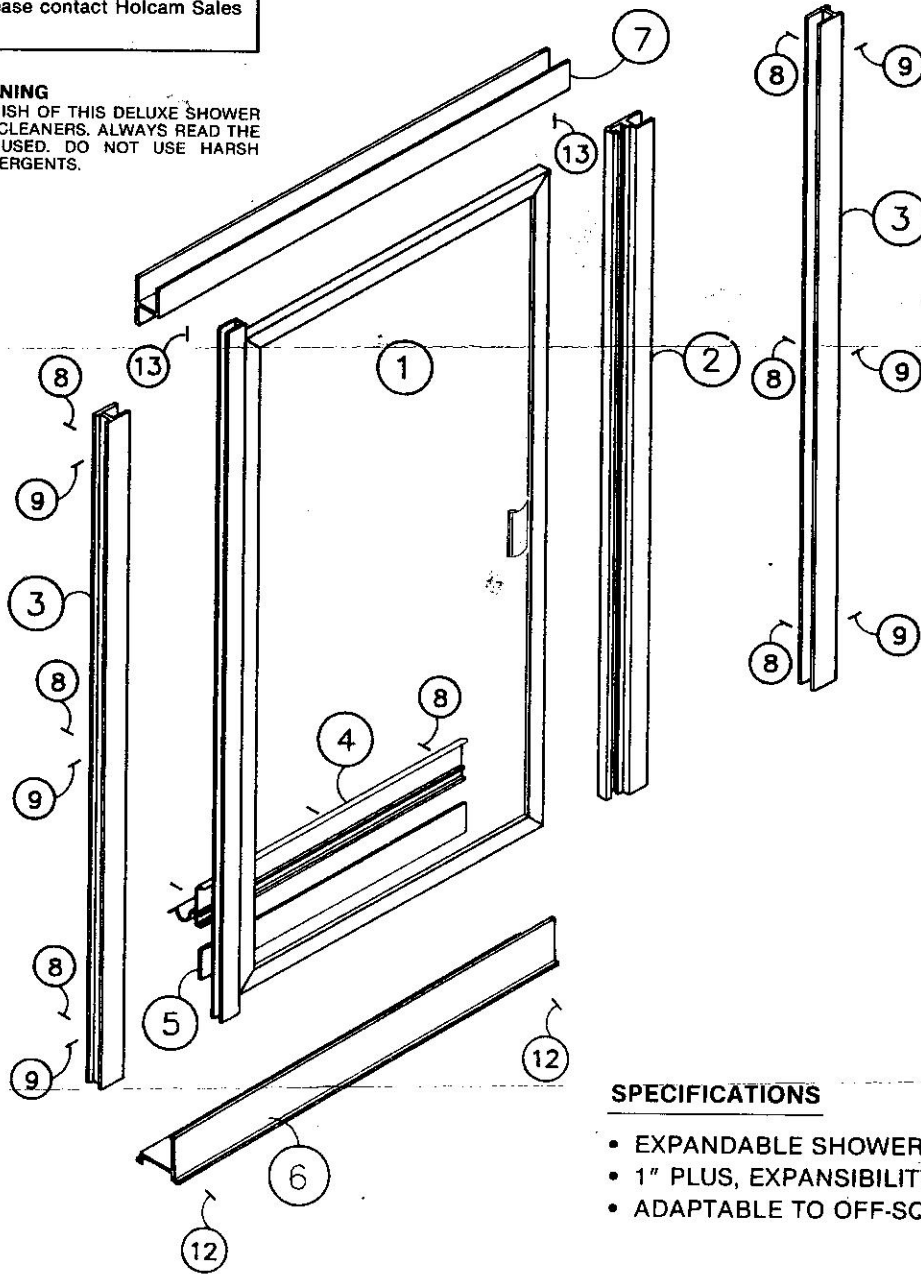

**SPECIFICATIONS**

- EXPANDABLE SHOWER DOOR
- 1" PLUS, EXPANSIBILITY
- ADAPTABLE TO OFF-SQUARE OPENINGS

**PARTS LIST**

ITEM	NAME	QTY.	PART NO.
1.	Door Assembly	1	
2.	Strike	1	H-3
3.	Wall Jambs	2	H-36
4.	Gutter	1	H-11
5.	Gutter Vinyl	1	V-8
6.	Threshold	1	P-25
7.	Top Strike	1	H-37

**HARDWARE PACK**

ITEM	NAME	QTY.
8.	No. 6 x 3/8 S.M. Screws	15
9.	No. 10 x 2 Pan Head Screws	6
10.	Plastic Anchors	6
11.	Gutter Plug	1
12.	6 x 3/4 Pan Head Screws	2
13.	10 x 2 Flat Head Screws	2

**NOTE:** Polarity of magnet may be reversed. To change polarity, remove magnetic strip from strike jamb, turn end for end and re-install in strike jamb.