



Family Owned Since 1971



**The Greatest Invention
Since the Internet
Give Us a Call**

1.800.426.3929

Cedarbrook Showroom

Phone:	800.426.3929 or 425.481.3333
Fax:	425.487.1695

Our Business Hours

M-F	8-5 PST
Sat	10-3 PST
Sun	Closed

Cedarbrook Sauna + Steam – Family owned and operated since 1971

We build cedar saunas, kits, sauna doors, accessories for commercial saunas & residential sauna rooms — AND we have the expertise to fit you with the right sauna heaters, steam room doors and steam room equipment.

If you are ever in the Seattle area, we have a showroom just northeast of the city where you'll find sauna and steam rooms plus accessories on display.

Our friendly staff is ready to answer your questions on what we do best: building and designing sauna rooms and doors, selecting the sauna heater that best fits your needs and answering any other questions regarding sauna and steam rooms.

If you have any questions regarding saunas and steam rooms, we're your resource!

Sweating the details since 1971

**Brekke Lysaker
Management**



Heater Model _____

Serial # _____

Installation Guide

ULTRA-SAUNA HEATER

Proudly made in USA since 1964

LARGE HEATERS 12.0-18.0 KW

Installation Instructions
& User Manual



BEFORE YOU START

- Heater and controls must be installed by a licensed electrician
- Heater must be installed according to local codes.
- Ensure all factory connections are tight. Wires may have come loose in shipping.
- Plastic must be removed from shell before operating heater.
- Sauna door must always open outward.
- Sauna door can never include a lock.

YOUR HEATER SHOULD INCLUDE

- Controls
- Main Heater Unit
- Sauna Rocks
- Thermostat sensor wall cover (not included with T-model heaters)
- Installation Instructions
- Warning Sign

HEATER SIZING

Ultra Sauna Heaters—Large (26" W x 18" D x 29" H)					
Model	Watts	Volts	Phase	Amps	Max Room Size
12240	12000	240	1	50	140 sq ft (44 sq m)
12240-3	12000	240	3	29	140 sq ft (44 sq m)
12208	12000	208	1	57.7	140 sq ft (44 sq m)
12208-3	12000	208	3	33.3	140 sq ft (44 sq m)
15240	15000	240	1	62.5	205 sq ft (63 sq m)
15240-3	15000	240	3	36.2	205 sq ft (63 sq m)
15208	15000	208	1	72.2	205 sq ft (63 sq m)
15208-3	15000	208	3	41.7	205 sq ft (63 sq m)
18240	18000	240	1	75	240 sq ft (73 sq m)
18240-3	18000	240	3	43.3	240 sq ft (73 sq m)
18208	18000	208	1	86.6	240 sq ft (73 sq m)
18208-3	18000	208	3	50	240 sq ft (73 sq m)
18480-3	18000	480	3	22	240 sq ft (73 sq m)

SAUNA ROOM VENTING GUIDELINES

Sauna room should be vented according to manufacturer's specifications or Scandia sauna room specification found in the Scandia sauna installation instructions. Improper ventilation is dangerous for the sauna user's health. When the door is under cut, there is no other venting required in small sauna rooms. You should have between 3/4" to 1" between the finished floor and the bottom of the door. If further venting is preferred or required, the inlet vent should be below the heater, or near the base of the heater. Outlet vent can be on the opposite wall of the heater under the top bench.

SAUNA HEATER GUARD RAIL PLACEMENT GUIDE

Description	12KW-18KW
A	Width Of Heater Shell 26"
B	Wall to Face of Heater 18"
C	Side of Heater to Wall (Min.) 8"
D	Height of Heater Shell 29"
E	Wall to Inside of Guard (Min.) 26"
F	Lower to Upper Mounting 28"
G	F.F. to Bottom Mount 10 3/4"
H	Heater Center to Wall (Min.) 22"
I	F.F. to Bottom of Heater 10"
J	Top of Heater to Ceiling (7ft.) 39"

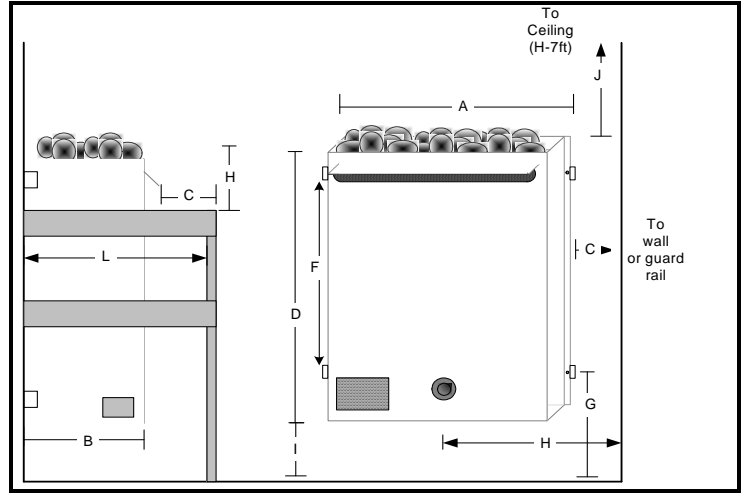

Minimum dimensions of heater guard must be 42" L x 26" d x 39" H—Top rail of guard must be below heater vent

CONTROL PANEL MODELS AND SIZES

A/B control: suitable for heater models 75240, 75208, 90240, 90208, 12208-3 (standard or T-model heaters)

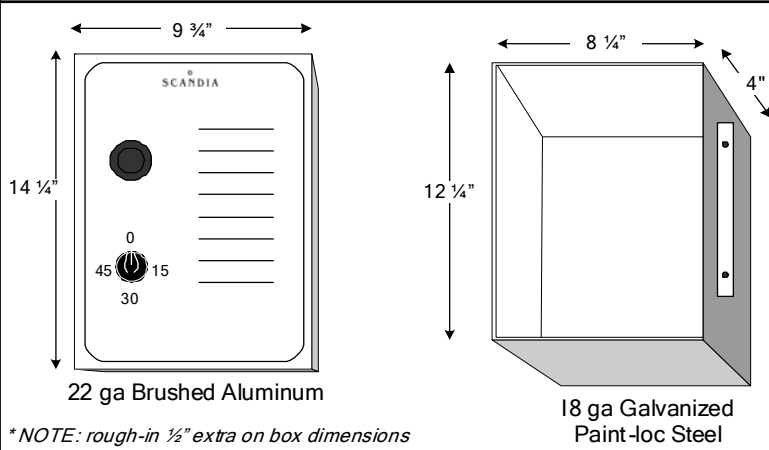

E control: suitable for heater models 12240, 12208, 15240, 15208, 18240, 18208, 18480 (standard or T-model heaters)

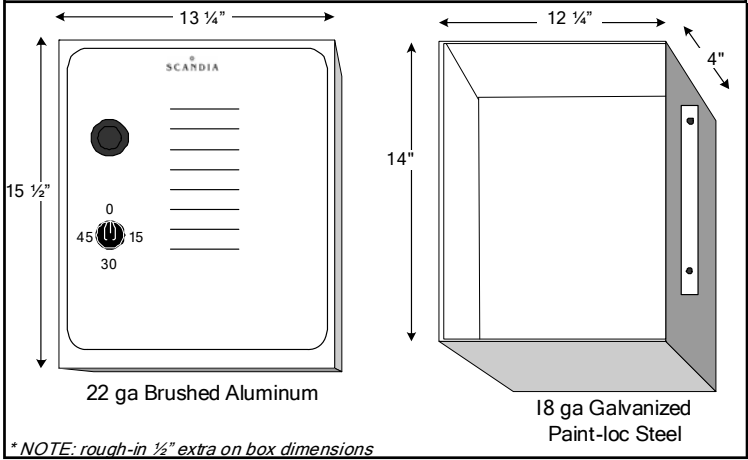

CONTROL PANEL LOCATION

All controls must be mounted on the outside of the sauna, NEVER inside the room.

RESIDENTIAL INSTALLATION – For convenience, place the control box at eye level by the door, approximately 12" from the door opening and 52" from the floor (see fig. 1). For conduit and wire size, type and quantities, see specific heater wiring diagram charts.

COMMERCIAL INSTALLATION – for 60-min timer, follow the residential installation recommendations. For 24-hour timer, you may place the control panel either in front of the sauna or in the mechanical or electrical room away from the sauna room. Please note that the thermostat capillary tube is only 4 ft long, therefore for controls placed away from the sauna, we recommend T-model heaters, where the thermostat is built in the heater itself.

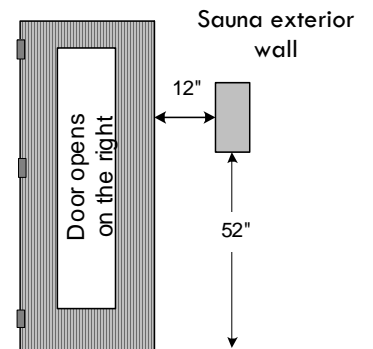

STANDARD HEATER / CONTROL CONFIGURATION

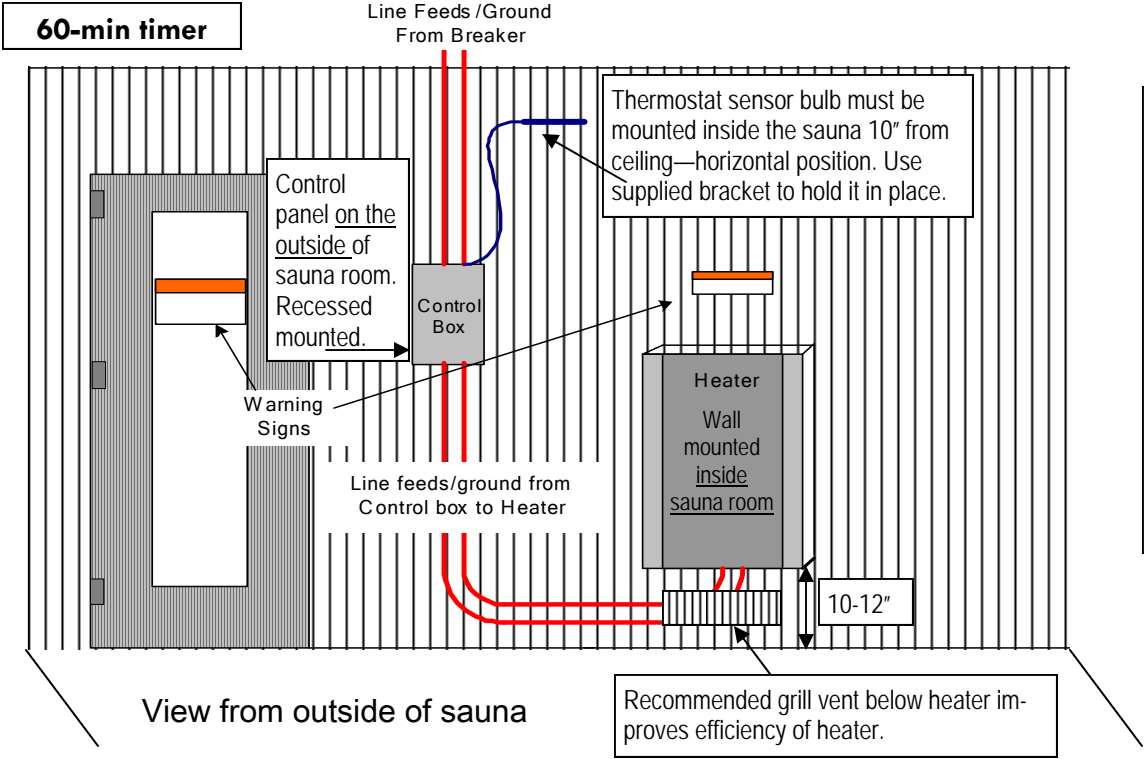

Note:
All Ultra-Sauna heaters can be ordered as T-model from factory. T-model heaters have the thermostat built in the heater, eliminating the need to have the thermostat sensor in the wall.

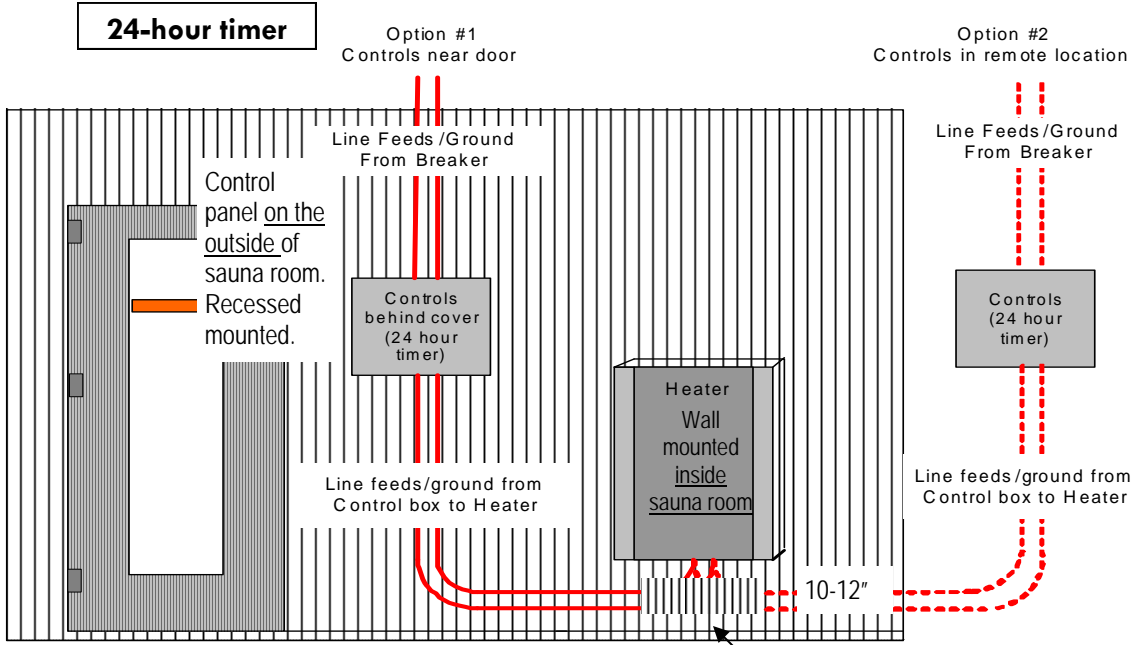

Important:
For controls in remote locations, T-model heater is recommended, please ask your Scandia sales representative.

IMPORTANT NOTES:

- Heater must be installed by a licensed electrician .
- Heater must be installed inside the sauna room and mounted c 10-12" from the floor .
- Controls must be installed outside of the sauna room .
- Thermostat capillary sensor bulb must be located inside the sauna room (horizontal position) approx . 10 inches from ceiling.
- All wiring must comply with Local and State ordinances : all wiring into the sauna room must be rated for at least 90 degrees Celsius (194 deg Fahrenheit) .
- Standard sauna ceiling height is 7 feet .
- Consult all local codes before installation .
- Warning signs must be installed at eye level on door and above heater .
- Door must always swing outward .
- Air intake vent must be installed below heater and an air exhaust vent should be installed .
- Thermostat should be placed behind cover and out of control of guests /members . Setting should be no higher than 180 degrees fahrenheit (85 Celcius)

WIRING DIAGRAMS

A3 control

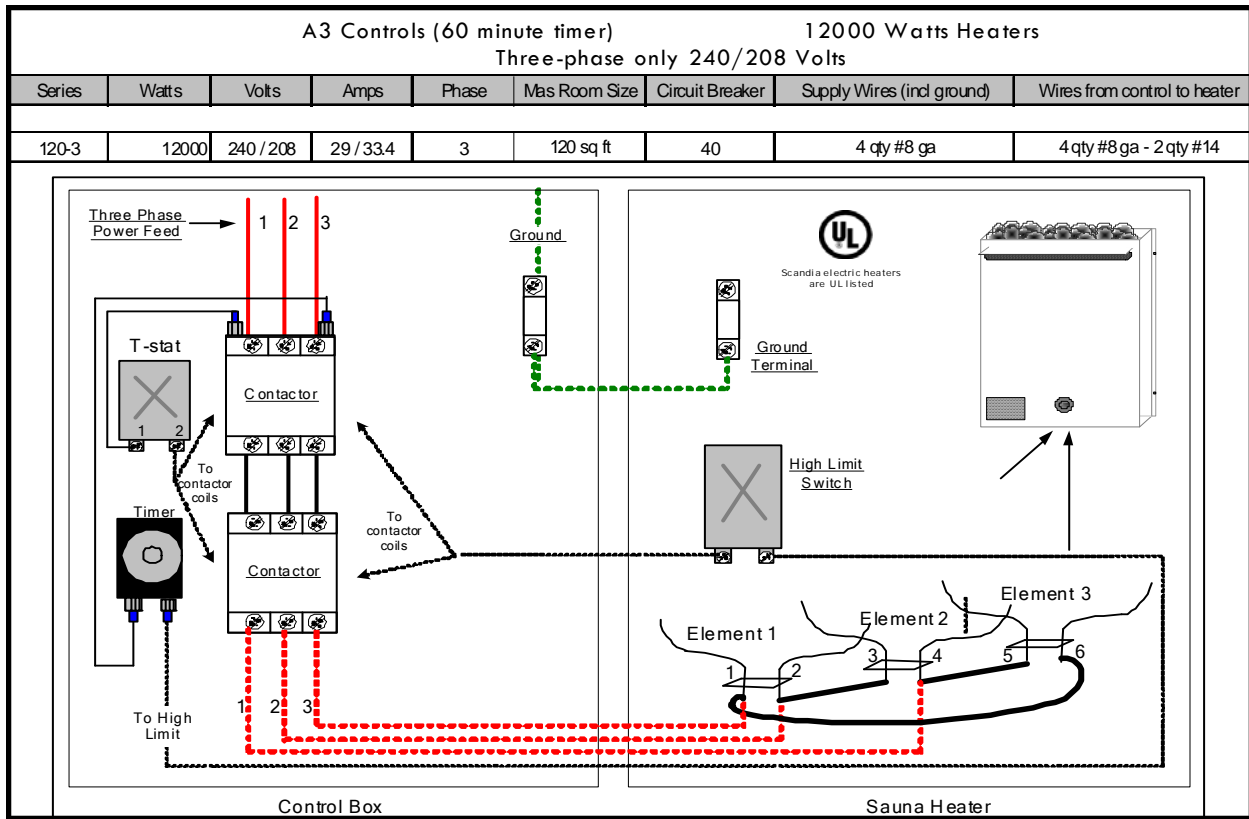

B3 control

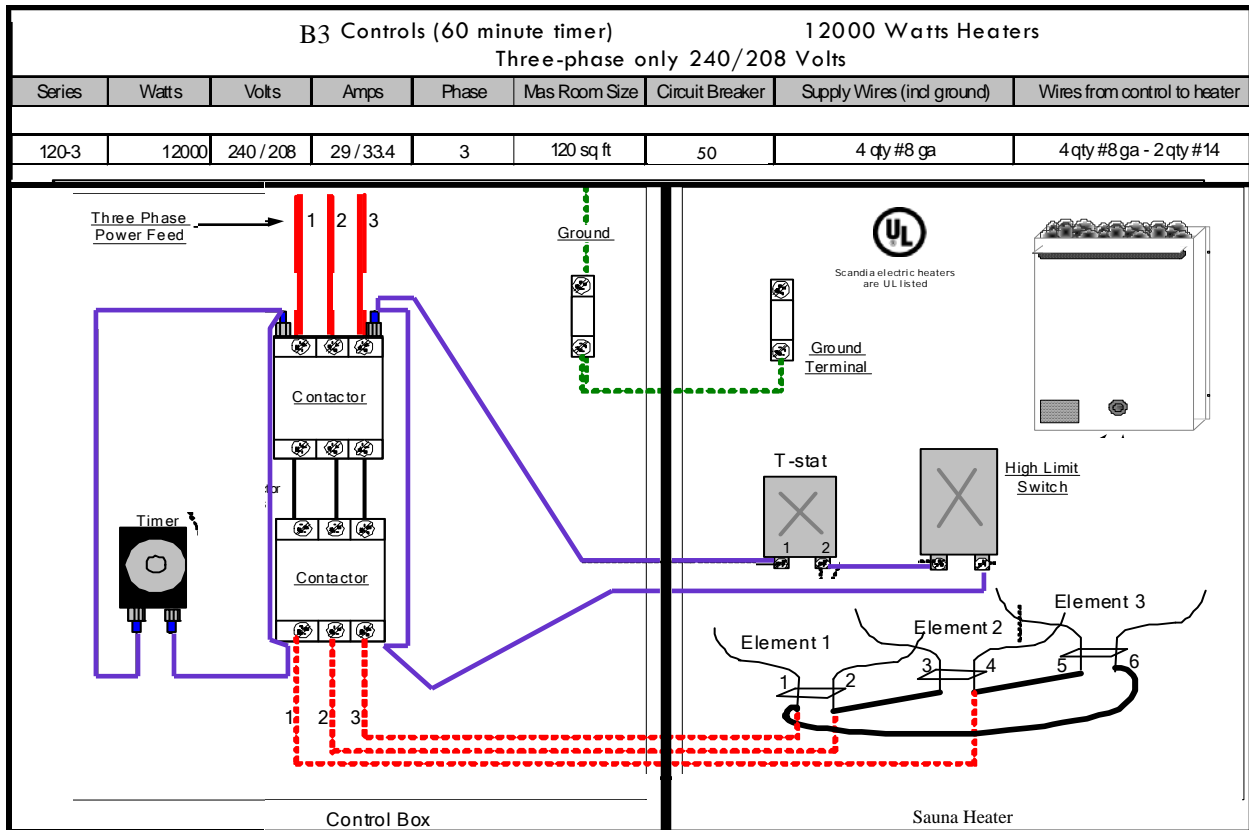

WIRING DIAGRAMS

E2 control

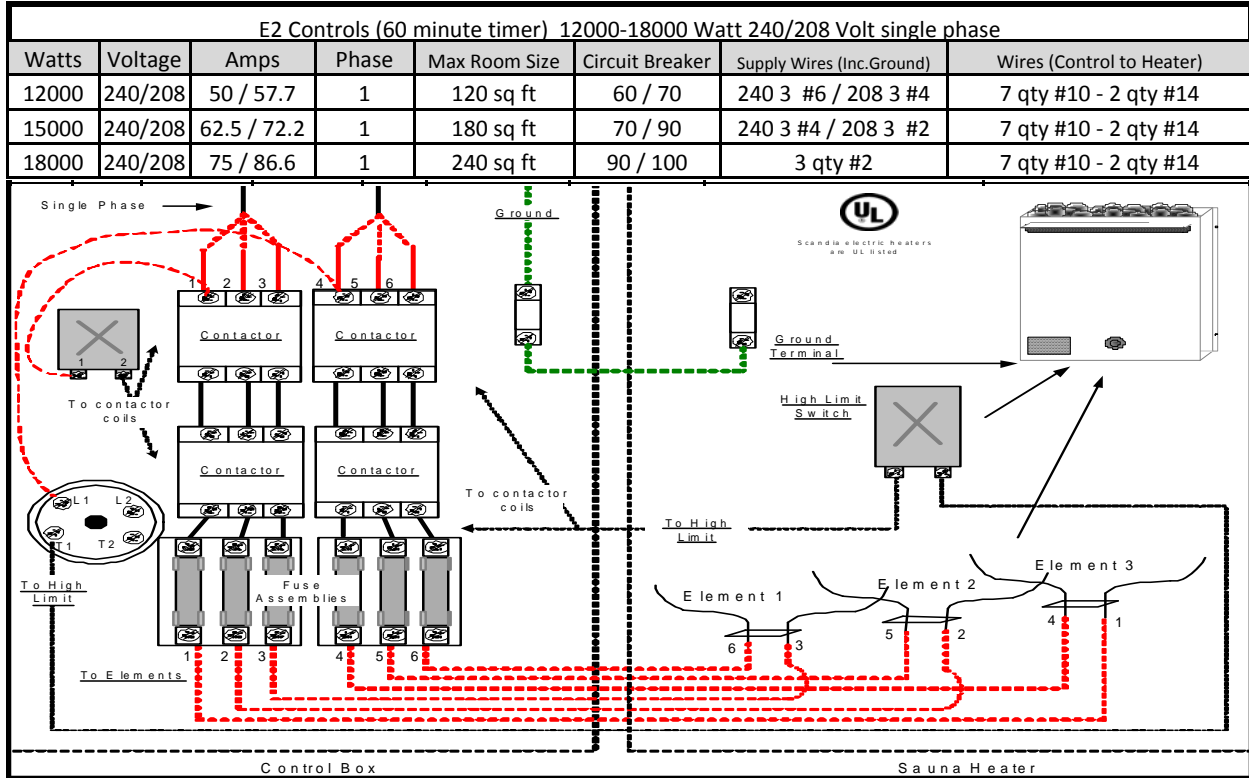

E2 control

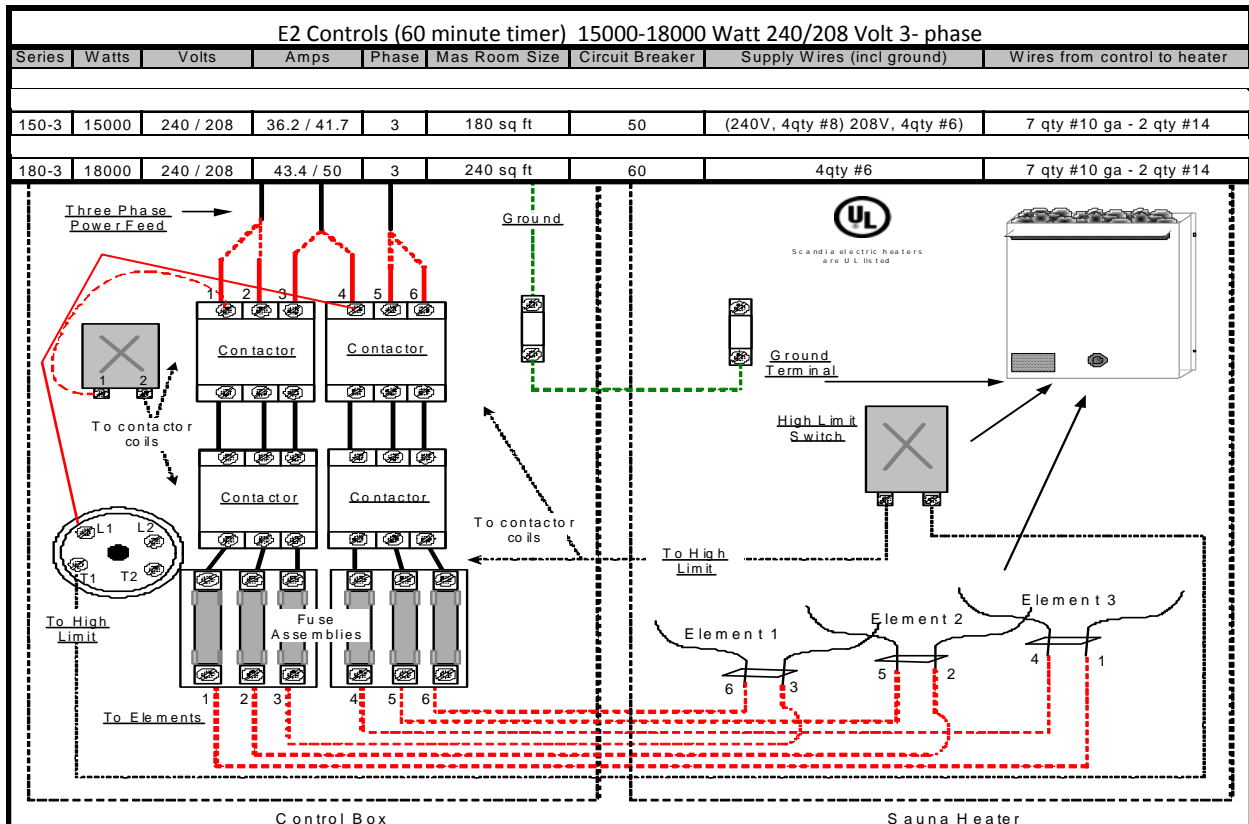

WIRING DIAGRAMS

E2 control

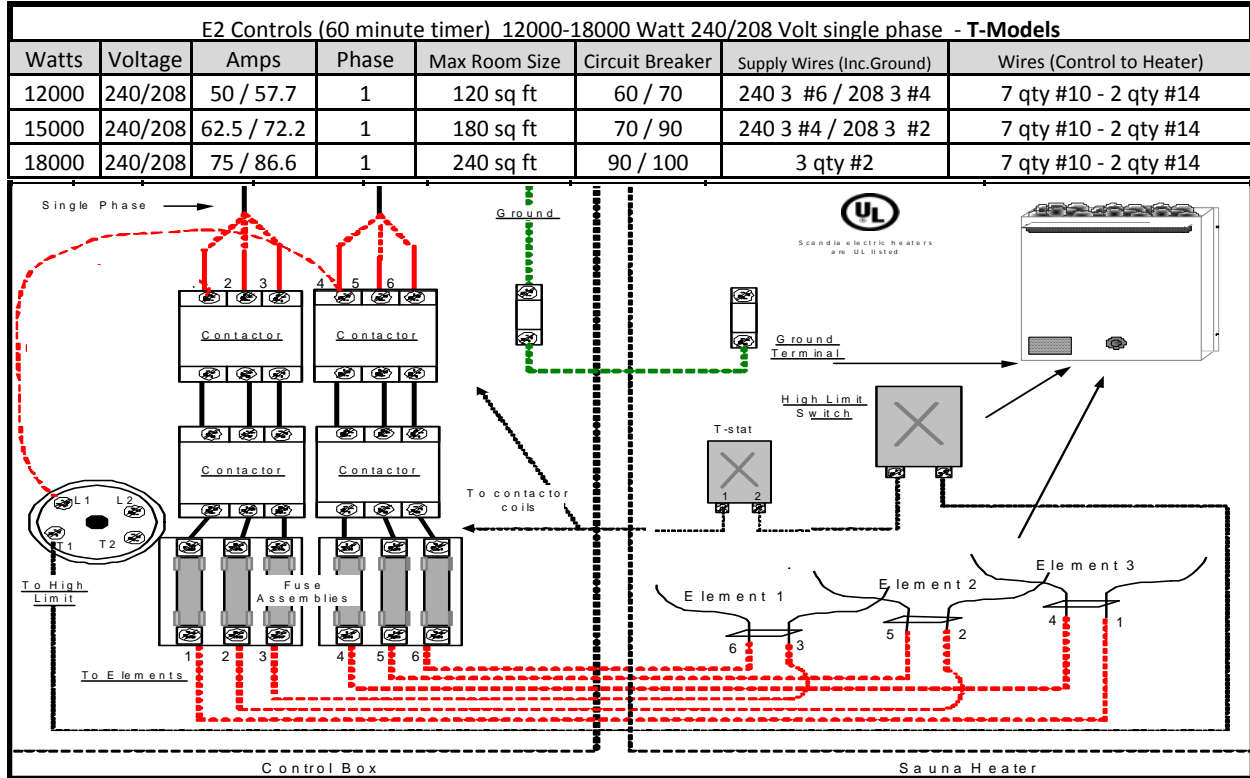

E2 control

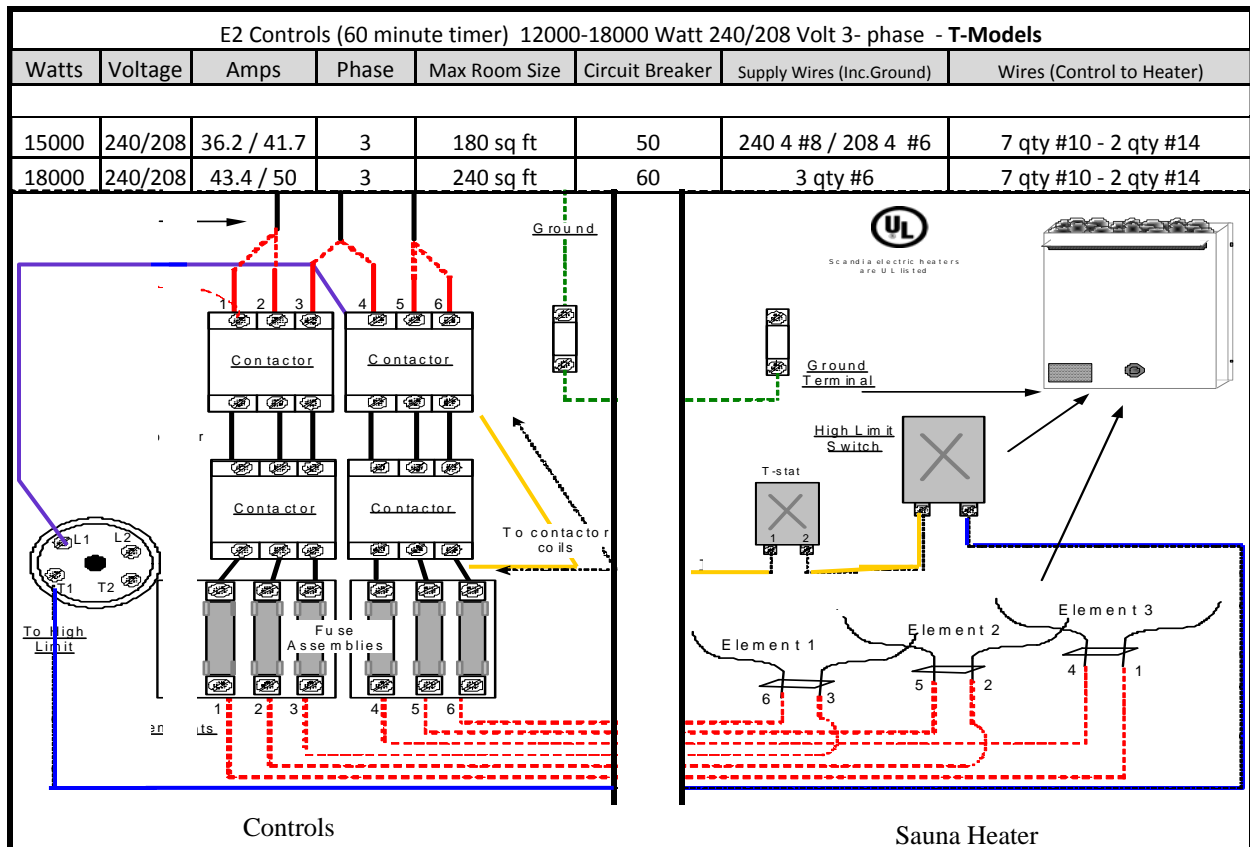

WIRING DIAGRAMS

Converting 60 minute timer to 24 hr programmable timer.

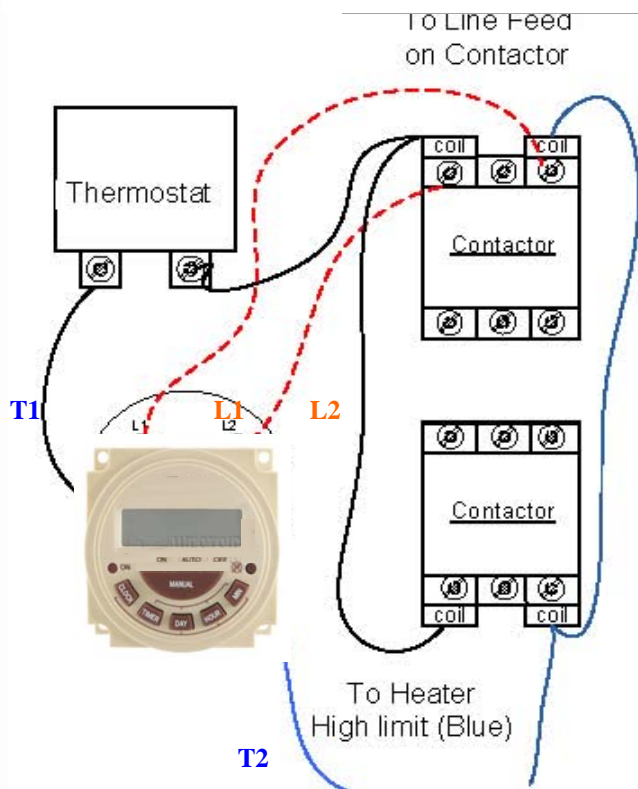
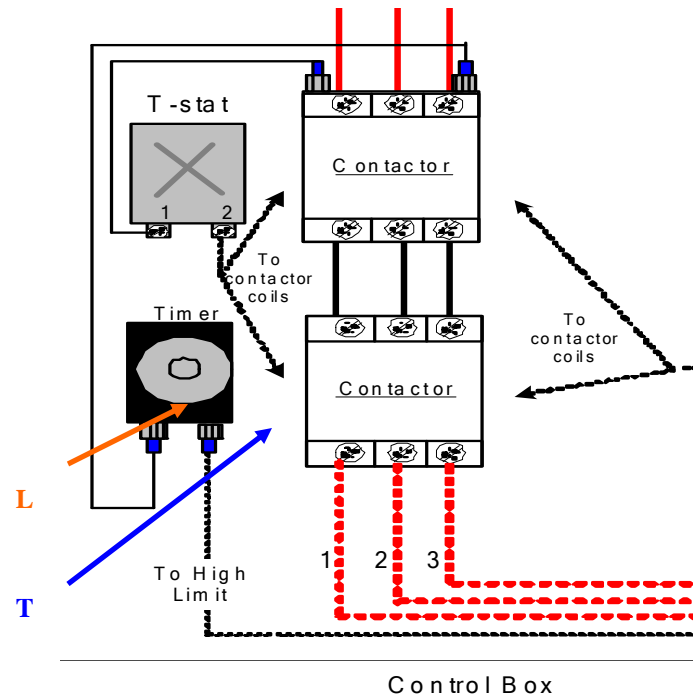

- Line feeds from Contactor connect to L1 & L2 on timer.
- T1 connects in series to Thermostat and to left coils of both contactors.
- T2 pig-tails connect to field high-limit wiring, which will return back to right side coils of both contactors.

SAUNA HEATER OPERATING INSTRUCTIONS

Installation steps:

- A. Remove the protective cover off the heater shell.
- B. Hang the heater in place or as specified by manufacturer.
- C. Fill the heater rock tray with the sauna rocks. **Note:** This sauna heater should not be operated without the recommended quantity of rocks.
- D. ENSURE GOOD AIR CIRCULATION AROUND SENSOR BULB.

Install the heater guard around rail around heater. After installation is completed, the heater should be turned on to maximum temperature for one hour to break any rocks having fault lines and to burn off the protective coating on the heater elements. **Do not enter the sauna room during the initial start-up.** The smell of smoke and cracking of rocks will not re-occur.

Sauna Timer:

Scandia' Sauna controls come with standard 60 minute timer (wall mounted outside the sauna) and thermostat . For T models, the thermostat is located on the heater. To turn on the heater, turn the timer knob up the desired time (up to the 60 min. mark). Leave knob at the setting and sauna will operate for one hour before shutting off automatically. Allow 30 minutes for room to heat up to an average sauna temperature. The thermostat is marked with numbers 1 through 10. With 1 being the coolest temperature and 10 the highest. Set the desired temperature. Note: Make sure the thermostat is on before setting up the time, otherwise the heater will not heat up."

For 24-hour timer operation, see attached Operating Guidelines for 24-hour digital timer.

Product Liability:

The buyer acknowledges that the goods sold to them by Scandia Manufacturing can cause property damage and personal injury if not properly sized, handled or installed. The buyer further agrees to indemnify and hold harmless Scandia Manufacturing from any or all claims for damage, loss and/or liability arising out of improper handling, sizing and/or installation of goods.

Programming Instructions

24 digital hour timer

To Set or Change the Day and Time:

To clear entire memory, press **CLOCK** key. Hold down the **CLOCK** key while pressing either the **DAY**, **HOUR** or **MINUTES** keys. Continue pressing until the desired day or number is shown. Then simply lift finger off of the **CLOCK** key to set.

To Set Program (ON/OFF times):

Press **TIMER** key once to enter into program mode. Display will show "1 ON - - - -". Press **DAY** key to choose any of 15 different day combinations for the first **ON** time. *Note: days of the week having the same program should be copied by selecting the desired combination of days.*

Press the **HOUR** key and then the **MINUTE** key to select the desired first **ON** time.

Press **TIMER** key once. Display will show "1 OFF - - - -". Repeat previous step to select the desired **OFF** time. Repeat the entire sequence to complete up to eight ON/OFF times as desired.

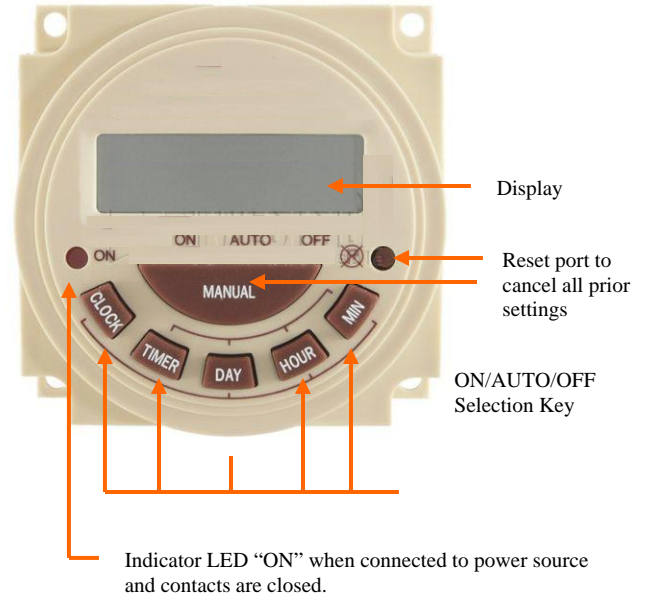

When programming is done, press the **CLOCK** key then the **MANUAL** key repeatedly until the indicator bar is above the word "AUTO"

To Review Program:

Press **TIMER** key repeatedly. When done, press **CLOCK** key to return to the time of day.

To Cancel/Change Part of the Program:

Press **TIMER** key repeatedly until the particular **ON** or **OFF** time appears, the repeatedly press the **DAY** key until the display show " - - - -". Set new **ON** and **OFF** time.

(See: To Set Programs)

To Override Automatic Operation:

Press **MANUAL** key to move indicator bar to the desired ON or OFF position.

*Note: Timer will not resume automatic operation until indicator bar is repositioned above the word **AUTO**.*

ULTRA SAUNA - WARRANTY

Your Ultra Sauna heater has been engineered and built to the highest quality standards, and is backed by this warranty to assure your complete satisfaction:

- (1) SCANDIA Mfg warrants on the terms and conditions set forth below for ten years to the Original Owner only, at the Original Installation site only, this equipment to be free from defect in material and/or workmanship under normal use as specified in the equipment's instructions, FROM DATE OF PURCHASE and thereafter.
- (2) A TEN YEAR LIMITED WARRANTY applies only on the heater unit as manufactured by and at SCANDIA Mfg., - Manufacturing Plant – and specifically excludes all components and/or parts which are accessories therein, namely: the gas valve; pilot generator; heating element; contactor; timer switch; thermostat; and, high limit, for which their respective manufacturers warranties apply. The TEN YEAR LIMITED WARRANTY does not apply for units that have been installed in commercial locations such as clubs, condominiums, apartments, spas or military facilities. In commercial locations, Scandia will provide a one-year warranty on the unit.
- (3) During the first year SCANDIA will, at its option, repair or exchange at the Factory all parts which it finds have become inoperative during said warranty period due to a defect in material or workmanship, without cost to customer except for freight and/or crating charges.
- (4) For the period commencing with the second year and for the ten year warranty of the original purchaser only, at the original installation only, SCANDIA will, at its option, repair or exchange at the Factory, all parts which it finds have become inoperative during said warranty period due to a defect in material or workmanship except the following parts which are excluded from this warranty: the gas valve; pilot generator; heating element; contactor; timer switch; thermostat; and, high limit.
- (5) This warranty in its entirety becomes null and void if unit is rented or to be used for rental purposes or installed in any mobile or fixed prefab rental room. If original purchaser is a corporation then, the president of said corporation, shall be construed as registered Original Owner for all purposes herein, otherwise this warranty in its entirety becomes null and void.
- (6) This warranty in its entirety becomes null and void if unit has been installed by an unlicensed party by and/or in the city and/or county where installation is made. Furthermore if unit is disassembled and/or tampered with in any way possible by any one (individual and/or company) then this warranty in its entirety becomes null and void.

SCANDIA reserves the right to substitute new equipment or parts on any orders for replacement hereunder, but shall not be obligated to do so. This warranty is solely for the benefit of the original purchaser and no one else, and only if the installation and operating instructions applicable to the model purchased are followed. These instructions are furnished with the unit and also are available by writing SCANDIA's warehouse. These instructions are incorporated herein by reference as if set forth in full. This warranty does not cover damages which appear to SCANDIA to have resulted from neglect, alteration, abuse, misuse, accident, flood, fire or other act of force majeure, or other than normal use.

This warranty is expressly in lieu of other warranties, or liabilities, express or implied, by the Company or its representatives, and in lieu of all other obligations and liabilities for damage to persons or property caused in any manner by the heater or its component parts. More specifically, by not by way of limitation, SCANDIA assumes no liability for damages which may occur as a result of neglect or intentional misuse of the unit, and the purchaser or user of the unit agrees to assume all liability for the consequences of its use or misuse by such purchaser or user, and his, its or their respective employees and agents or other third person. **THERE ARE NO WARRANTIES WHICH EXTEND BEYOND THE DESCRIPTION ON THE FACE HEREOF. NO REPRESENTATION OR WARRANTIES ARE MADE, EXPRESSED OR IMPLIED, OTHER THAN THOSE EXPRESSLY HEREIN SET FORTH TO THE ORIGINAL PURCHASER ONLY.**

To obtain the benefits of this Warranty, the inoperative parts and/or complete heater must be sent to Scandia, all shipping and crating charges prepaid. And all repaired or replaced parts or heaters will be returned freight collect. This warranty is effective only when the attached Factory Registration Stub is completed and returned to the manufacturer. Please contact Scandia for return authorization at 877-467-2862 or via e-mail info@scandiamfg.com

Warranty stub must be mailed or completed online within thirty DAYS TO REGISTER AND VALIDATE THIS WARRANTY, WHICH BECOMES VALID ONLY IF THE HEATER HAS BEEN PURCHASED DIRECTLY FROM SCANDIA MFG., AND/OR AUTHORIZED DEALERS IN U.S.A., its territories or possessions.

TO VALIDATE WARRANTY VISIT WWW.SCANDIAMFG.COM/PRODUCT_REGISTRATION.HTML AND REGISTER YOUR PRODUCT. ALL PRODUCTS MUST BE REGISTERED PRIOR TO ANY WARRANTY CLAIMS.

